

Benq FP78 I

LCD Color Monitor

17.0" (43.18 cm) LCD Panel Size

User's Manual

BenQ

Copyright

2002. Benq Corporation (formerly Acer Communications & Multimedia Inc.). All rights reserved. No part of this publication may be reproduced, transmitted, transcribed, stored in a retrieval system or translated into any language or computer language, in any form or by any means, electronic, mechanical, magnetic, optical, chemical, manual or otherwise, without the prior written permission of Benq Corporation.

Disclaimer

Benq Corporation makes no representations or warranties, either expressed or implied, with respect to the contents hereof and specifically disclaims any warranties, merchantability or fitness for any particular purpose. Further, Benq Corporation reserves the right to revise this publication and to make changes from time to time in the contents hereof without obligation of Benq Corporation to notify any person of such revision or changes.

Safety Instructions

1. The AC adapter isolates this equipment from the AC supply.
2. Unplug this product from the wall outlet before cleaning. Do not use liquid or aerosol cleaners. Use a soft cloth to clean the monitor housing and a tape to stick dust and fingerprints on the screen panel.
3. Slots and openings on the back or top of the cabinet are provided for ventilation. They must not be blocked or covered. This product should never be placed near or over a radiator or heat register, or in a built-in installation unless proper ventilation is provided.
4. This product should be operated from the type of power indicated on the marking label. If you are not sure of the type of power available, consult your dealer or local power company.
5. Never push objects of any kind, or spill liquid of any kind into this product.
6. Do not attempt to service this product yourself, as opening or removing covers may expose you to dangerous voltages or other risks. If any above mentioned misuse or other accident (dropping, mis-operations) occurs, contact qualified service personnel for servicing.
7. The power supply cord serves as a power disconnect device for pluggable equipment. The socket outlet shall be installed near the equipment and shall be easily accessible.

**Table
of
Contents**

Unpacking	3
Views of the Monitor	4
Front View (1)	4
Front View (2): Control panel	4
Back View (1)	5
Back View (2): Locations of plugs & sockets	5
Installation	6
Hardware Installation	6
Software Installation	7
Adjusting the Monitor	37
Hot Key Mode	37
Main Menu Mode	38
Troubleshooting	45
Frequently Asked Questions (FAQ)	45
Need More Help?	46
Supported operating modes	47
Specifications	48
Appendix: An Introduction to LCD Technology	49
Principles of LCD Technology	49
The TFT panel	49
Important LCD parameters	50
Display errors	51
Comparison of CRT & LCD monitors	52
Summary	52

Unpacking

Please check you have the following items. If they are missing or are damaged, please contact the dealer immediately at which you purchased the good.

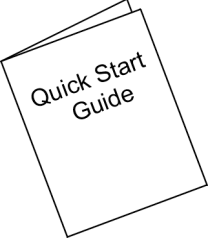
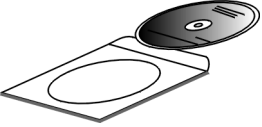
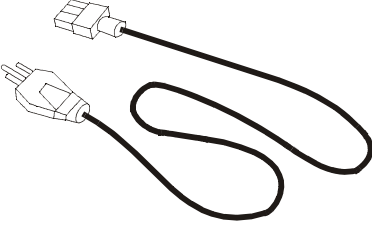
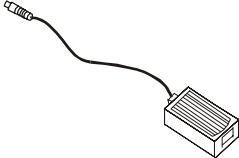
LCD monitor with signal cable	
Quick Start Guide	
CD-ROM	
Power cord	
Power Adaptor	

Views of the Monitor

Front View (1)



Front View (2): Control panel

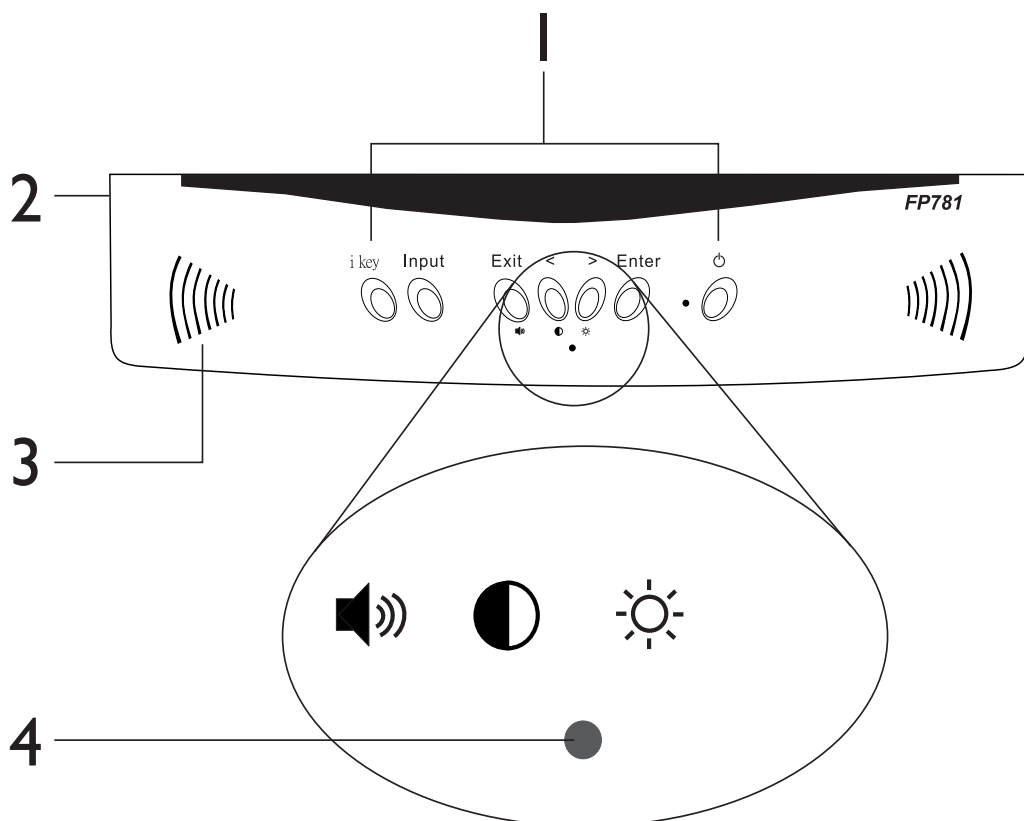

1. Control key	2. Earphone jack
3. Speaker	4. Microphone

Back View (1)

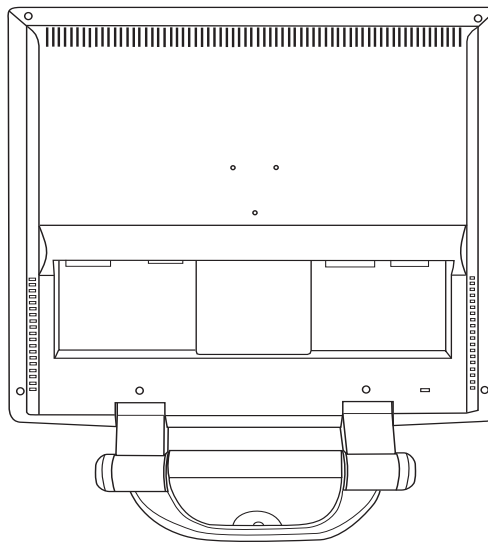

Back View (2): Locations of plugs & sockets

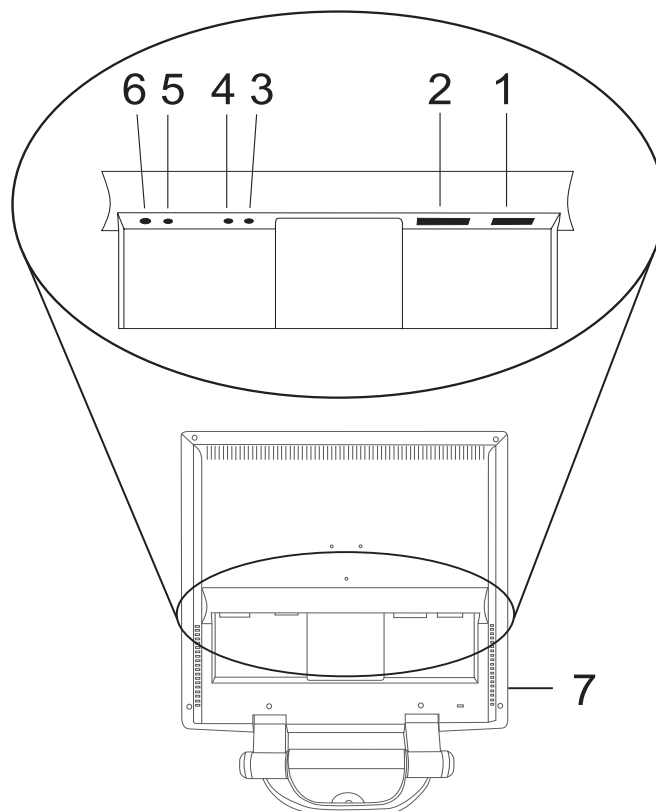

1. D-sub connector	2. DVI connector
3. Microphone input socket (MIC)	4. Audio in socket (LINE IN)
5. DC 5V output socket (DC5V)	6. DC 12V input socket (DC12V)
7. Earphone jack	

Installation

Hardware Installation

A. Make sure that the computer and monitor's power are both turned off. Please follow the steps to install your LCD monitor.

- 1 . Connect the signal cable and power adaptor to Benq LCD monitor.
- 2 . Connect the audio cable to the Audio Input of Benq LCD monitor.
- 3 . Please connect power cord to power adaptor first and then connect the power adaptor to LCD monitor.

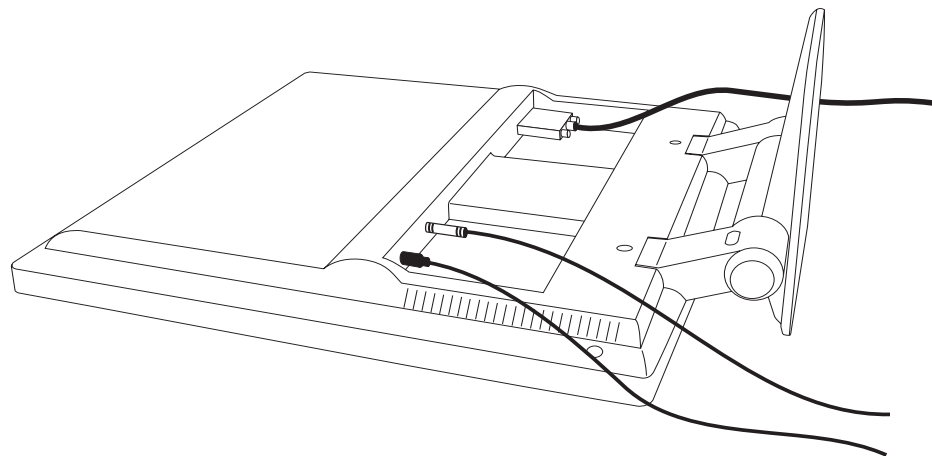

- B. Connect the signal cable to the VGA output of the graphics card on the computer.
- C. Connect the audio cable to your computer.
- D. Connect the power cord at the back of the monitor to an AC power socket. Please make sure that the socket is not blocked or covered, so you can disconnect the unit from AC supply if you need to. Your monitor is equipped with an automatic power supply for a voltage range from 100 to 240 Volt at a frequency of 50 to 60 Hz. Be sure that your local power is within the supported range. If you are unsure, ask your electricity supplier.

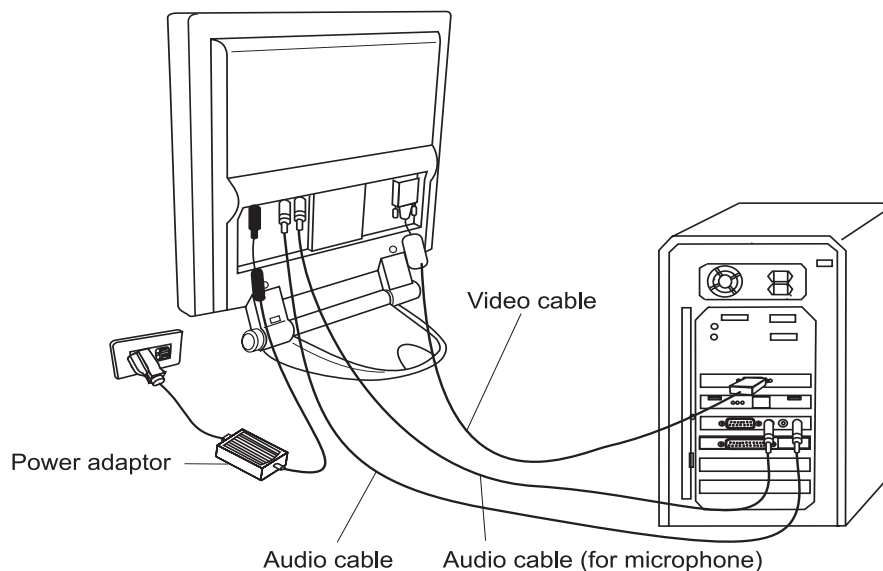

Adjusting the Monitor

A Look at the Control Panel

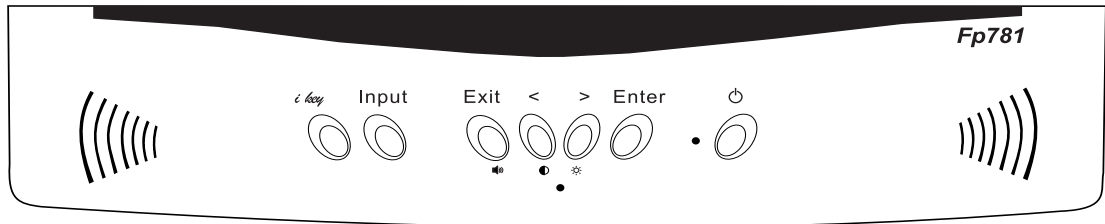

There are 7 keys for user's control including "iKey", "Input", "Exit", "Enter", "<" and ">" key and a power switch. The following descriptions are the introduction of these keys & switch.

1. "Power": Turn the power on or off.
2. "iKey" : Adjust vertical position, phase, horizontal position and pixel clock automatically.
3. "Input" key: Select between digital and analog signal sources.
4. "Exit" key: Back to main menus, save menu or exist OSD menu
5. "Enter" key: Enter sub-menus, select items or save items.
6. "<": For Left adjustment. Left key is the hot key for Contrast adjustment.
7. ">": For Right adjustment. Right key is the hot key for Brightness adjustment.

Hot Key Mode

Contrast hot-key

1. Press "<" key to enter the Contrast hot-key mode.
2. Press "<" or ">" key to make adjustment. The scale can be adjusted from maximum (100) to minimum (0).
3. Press the "Exit" to leave OSD operation. The adjustment can be auto-saved.



Brightness hot-key

1. Press ">" key to enter the Brightness hot-key mode.
2. Press "<" or ">" key to make adjustment. The scale can be adjusted from maximum (100) to minimum (0).
3. Press the "Exit" to leave OSD operation. The adjustment can be auto-saved.



Volume hot-key

1. Press “Exit” key to enter the Volume hot-key mode.
2. Press “<” or “>” key to make adjustment. The scale can be adjusted from maximum (100) to minimum (0).
3. Press the “Exit” to leave OSD operation. The adjustment can be auto-saved.

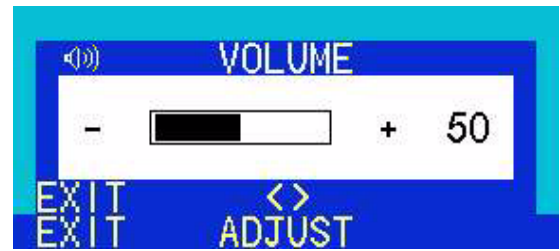

Main Menu Mode

Control Functions Available in Main Menu

Digital mode OSD main menu.



Analog mode OSD main menu.



Brightness

Press “<” or “>” key to select this item and press “Enter” to enter sub-menu.



Press “<” or “>” key to adjust brightness and then press “Exit” to return to main menu.





Fine Tune

Press “<” or “>” key to select this item and press “Enter” to enter sub-menu.



There are two items in this sub-menu.

 Phase: adjust the phase of pixel clock.

 Pixel Clock: adjust the frequency of the pixel.



Auto Adjust

The same function as iKey

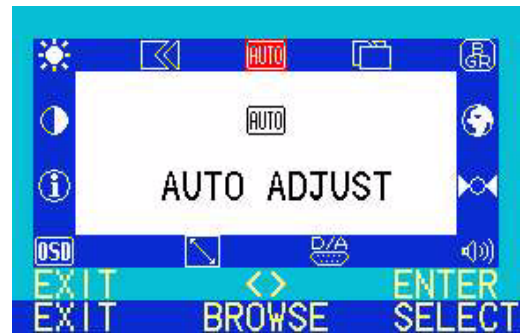



Position

Press "<" or ">" key to select this item and press "Enter" to enter sub-menu.



There are two items in this sub-menu.

 H.(Horizontal) Position: adjust the horizontal position of the display.

 V.(Vertical) Position: adjust the vertical position of the display.

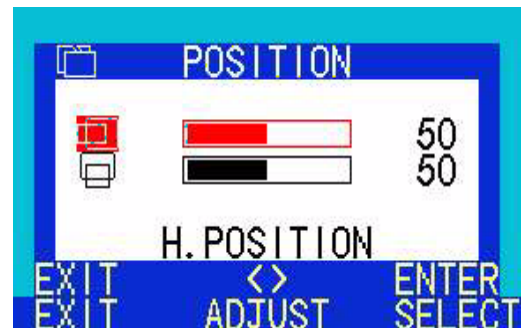

Color

Press "<" or ">" key to select this item and press "Enter" to enter sub-menu.



There are three preset modes:

C1:9300K

C2:6500K

C3:5800K

And one user mode.



In user mode, user can adjust Red, Green and Blue color.

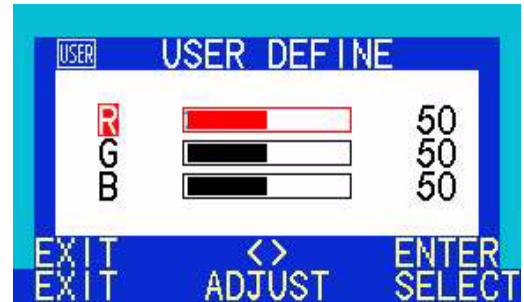

Languages

Press “<” or “>” key to select this item and press “Enter” to enter sub-menu.



To select OSD language within 6 languages

DE: Deutsch

EN: English

ES: Español

FR: Français

IT: Italiano

JA: Japanese



Recall

Press “<” or “>” key to select this item and press “Enter” to enter sub-menu.



Press "<" or ">" key to make decision. Select "Yes" and press "Enter" to restore factory settings. Select "No" and press "Enter" or just press "Exit" to return to main menu.



Volume

Press "<" or ">" key to select this item and press "Enter" to enter sub-menu.



Press "<" or ">" key to adjust volume of speaker and then press "Exit" to return to main menu.



Input Select

Press "<" or ">" key to select this item and press "Enter" to enter sub-menu.

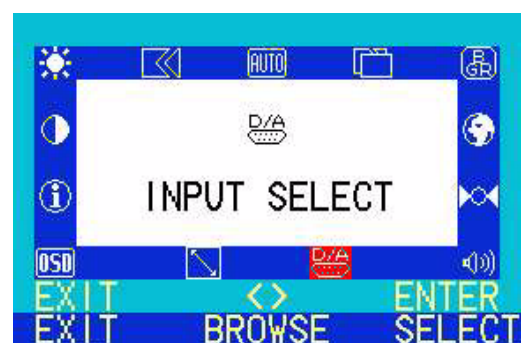

Press "<" or ">" key to select between digital and analog signal source.

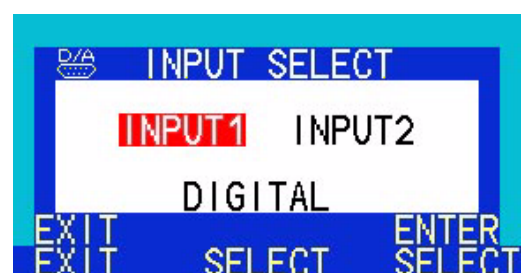
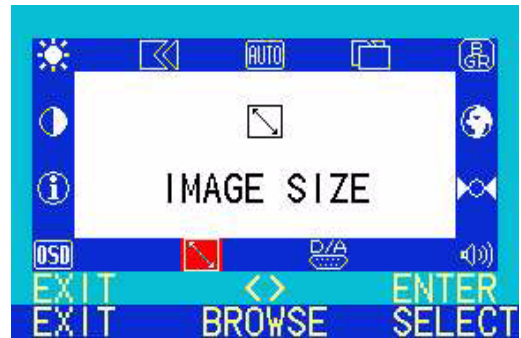

Image Size

Press “<” or “>” key to select this item and press “Enter” to enter sub-menu.



Press “<” or “>” key to select between "FULL" (full screen) and "1:1" (real size).





OSD Setting

Press “<” or “>” key to select this item and press “Enter” to enter sub-menu.



There are 3 items in this sub-menu.

 H.(Horizontal) Position: adjust the OSD horizontal position of the display.

 V.(Vertical) Position: adjust the OSD vertical position of the display.

 OSD Time: to set the standby time of OSD.

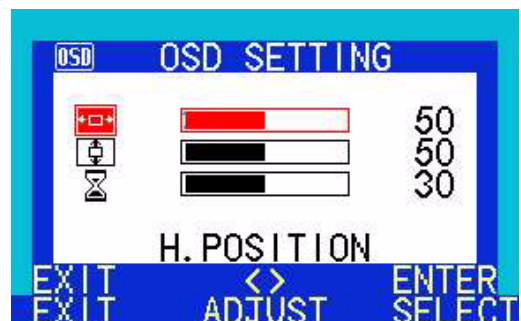

Info

Press “<” or “>” key to select this item and press “Enter” to enter sub-menu.

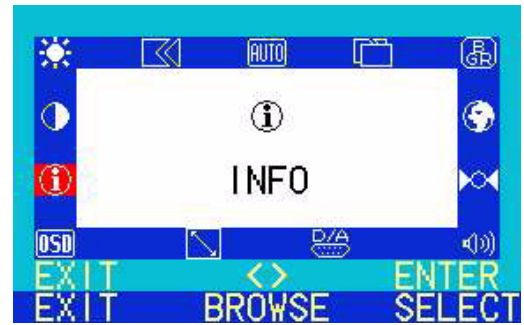

Press "Enter" to show display information (resolution, horizontal frequency and vertical frequency). Press "Exit" to return to main menu.



Contrast

Press “<” or “>” key to select this item and press “Enter” to enter sub-menu.



Press “<” or “>” key to adjust contrast ratio and then press "Exit" to return to main menu.



Troubleshooting

Frequently Asked Questions (FAQ)

✓ The image is blurred:

- ☞ Read the chapter, Installation/Adjustment and then select the correct resolution, refresh rate and make adjustments based on these instructions.
- ☞ Do you use a VGA extension cable?

Remove the extension cable for the test. Is the image now in focus? If not, optimize the image working on the description in the chapter, Installation/Adjustment. It is normal for blurring to occur due to conduction losses in extension cables. You can minimize these losses by using an extension cable with better conduction quality or with a built-in booster.

- ☞ Does the blurring only occur at resolutions lower than the native (maximum) resolution?

Read the chapter Installation/Adjustment. Select the native resolution.

✓ Pixel errors can be seen:

- ☞ One of several pixels are permanently black, one or more pixels are permanently white, one or more pixels are permanently red, green, blue or another colour.

Read the chapter Pixel error rates.

✓ The image has a faulty colour appearance:

- ☞ It has a yellow, blue or pink appearance.

On the monitor press the "Enter" key and use "<" or ">" key to select "RECALL" item and press "Enter" key. Press "<" or ">" key to select "YES" and press "Enter" to recall factory settings. If the image is still not correct and the OSD also has a fault colour appearance, then one of the three primary colours is missing in the signal input. Now check the VGA cable contacts. If any pins are bent or broken off, then contact your dealer or read the chapter, Additional Help, Repairs & Service.

✓ No image can be seen:

- ☞ Is the prompt on the display illuminated in green?

If the LED is illuminated in green, then press the "Enter" button on the monitor to access the On Screen Display. If the message "Not supported Mode" appears there, read the chapter Installation/Adjustment.

- ☞ Is the prompt on the display illuminated in orange?

If the LED is illuminated in orange, then the power management mode is active. Press a button on the computer keyboard or move the mouse. If that does not help, then check the VGA cable contacts. If any pins are bent or broken off, then contact your dealer or read the chapter, Additional Help, Repairs & Service.

- ☞ Is the prompt on the display not illuminated at all?

Check the power supply mains socket, the external power supply and the mains switch.

✓ **The image is or distorted, flashes or flickers:**

- ☞ Read the chapter, Installation/Adjustment and then select the correct resolution, refresh rate and make adjustments based on these instructions.

✓ **The image is displaced in one direction:**

- ☞ Read the chapter, Installation/Adjustment and then select the correct resolution, refresh rate and make adjustments based on these instructions.

Need More Help?

If your problems remain after checking this manual, please contact your place of purchase or e-mail us at: DPLservice@benq.com

Supported operating modes

Incoming display mode(Input timing)					Multi-scan operation
Resolution	Horizontal Frequency (KHz)	Vertical Frequency (Hz)	Dot Clock Frequency (MHz)	Remark	Actual display resolution
640x350	31.47(P)	70.08(N)	25.17	DOS	1280X943
720x400	31.47(N)	70.08(P)	28.32	DOS	1280X1024 full screen
640x480	31.47(N)	60.00(N)	25.18	DOS	
640x480	35.00(N)	67.00(N)	30.24	Macintosh	
640x480	37.86(N)	72.80(N)	31.5	VESA	
640x480	37.50(N)	75.00(N)	31.5	VESA	
800x600	37.88(P)	60.32(P)	40.00	VESA	
800x600	48.08(P)	72.19(P)	50.00	VESA	
800x600	46.86(P)	75.00(P)	49.50	VESA	
832x624	49.72(N)	74.55(N)	57.29	Macintosh	
1024x768	48.36(N)	60.00(N)	65.00	VESA	
1024x768	56.48(N)	70.10(N)	75.00	VESA	
1024x768	60.02(P)	75.00(P)	78.75	VESA	
1024x768	60.24(N)	74.93(N)	80.00	Macintosh	
1152x864	67.50(P)	75.00(P)	108.00	VESA	
1152x870	68.68(N)	75.06(N)	100.00	Macintosh	
1152x900	61.80(N)	66.00(N)	92.94	SUN 66	
1152x900	71.81(N)	76.14(N)	108.00	SUN	
1280x1024	64.00(P)	60.00(P)	108.00	VESA	
*1280x1024	75.83(N)	71.53(N)	128.00	IBMI	
*1280x1024	80.00(P)	75.00(P)	135.00	VESA	
*1280x1024	81.18(N)	76.16(N)	135.09	SPARC2	

- Modes, which are not listed in the above table, may not be supported. For an optimal picture it is recommended to choose a mode listed in the table.
- You have 22 available modes compatible with Windows.
- It can happen that the image is disrupted. This can occur as a result of a signal frequency from the VGA card, which does not correspond with the usual standard. This is not, however, an error. You can improve this situation by altering an automatic setting or by manually changing the phase setting and the pixel frequency from the "Fine Tune" menu.
- If you switch off the monitor, interference lines can occur on your screen. But do not be concerned about this, as it is normal.
- To extend the service life of the product, we recommend that you use your computer's power management function.
- Note: The "*" timing is not supported in Digital input (DVI-D).

Specifications

Model	FP781
Display type	17.0" ,active, TFT
Viewable diagonal	43.18cm
Native (maximum) resolution	1,280X1,024
Colors	16.7 million
Contrast / Brightness	350:1 / 200cd/m ²
Response time	35ms
Viewing angle (left/right, up/down)	80/80, 80/80
Line frequency	31.47 - 81.18 kHzMulti- frequency monitor
Image frequency	56.25 - 75.0 Hz modes within these parameters
Image checks	Digital, Screen OSD Technology, iKey (automatic image setting)
Controls	iKey, Input, Exit, "<", ">", Enter
iScreen functions	Contrast, brightness, vert. & hor. image position, phase, pixel clock, color balance, color palette, choice of language, Input Select, Image Size, OSD Setting, Status indicator.
Power Management	VESA DPMS, EPA
max. power consumption	50 Watt Max
Power saving mode	< 3 Watt
Input signal	Analog: RGB analog 0.7 Vpp/75 Ohm positive Digital: DVI (Digital Visual Interface Standard Rev. 1.0) compliance
Synchronisation	TTL separate signal connection 15-pin mini D-sub cable
Signal connection	Analog: 15 pin mini D-sub cable Digital: 24 pin DVI cable
Temperature (operating)	5 °C - 40 °C
Air humidity (operating)	20% - 80%
Certifications	TCO 99 (Optional), TÜV/Ergonomics, TÜV/GS, FCC Class B, ISO 13406-2, VCCI, UL, CE, C-Tick, BSMI
Operating voltage	Automatic switched mode power supply, 90-264 V, 47-63Hz
Dimensions (W x H x D)	404.6 x 449.6 x 202.1 mm
Weight	4.7 kg

Appendix: An Introduction to LCD Technology

Principles of LCD Technology

The functionality of LCD (Liquid Crystal Display) screens is based on the special physical properties of liquid crystals. Their rod shaped molecules arrange themselves similarly to the molecules of crystals - always uniformly and in one particular direction. Yet liquid crystals are not set in this orientation, but behave like a liquid: They can be manipulated by applying an electric voltage. The layers of the liquid crystal molecules can therefore be longitudinal or diagonal to the polarising direction of the light and thereby have a varying effect on the course of light waves.

LIQUID CRYSTALS POLARISE INCIDENT LIGHT

An LC display consists of two polarising filters, a control layer, the respective colour filters and the liquid crystal layer.

The light from a background lamp hits an initial polarisation membrane so that only a specific plane of polarisation of the light reaches the liquid crystal layer. Without any external electrical influence the liquid crystal molecules arrange themselves in a screw-like shape between the two vertically aligned polarising filters and the directional structure imposed as a result. The light follows this orientation and is rotated by 90 degrees. The second polarising filter only allows through light with this rotated polarisation. The light valve is open - as a result the controlled pixel lights up.

If an electrical voltage is applied, the liquid crystal molecules orientate themselves along the field lines. The 90° screw is lifted up, the LC molecules appear parallel to the incident light and allow it to pass through without altering the polarising direction. The unrotated light hits the second, rotated polarising filter and is blocked. As a result the corresponding pixel remains dark. The intensity of the departing, visible light can be controlled by means of the voltage applied to the crystal layer and the polarised light rotated to a greater or lesser extent as a result.

The TFT panel

A. The standard TFT panel

With TFT displays, also called active matrix, the light transmitting capacity of each pixel is in each case controlled by a transistor. The pixels can therefore be operated individually and addressed very quickly, which in turn guarantees perfect display even of moving images. With high-resolution LCDs well over two million pixels (three colour dots for the primary colours red, green and blue per pixel) have to be controlled. The voltage is continuously on so that the image does not have to be rebuilt constantly. The great advantage of this is that LC displays do not flicker, even when they are controlled at low refresh frequencies (e.g. at 60 Hz). Because faulty transistors can occur during production, pixel errors resulting from this are unavoidable.

B. The super TFT panel

The super TFT panel works according to the same physical principle. A significantly increased viewing angle can be created through more precise production and through slightly brighter pixels. This, however, is partly at the expense of the gray level resolution.

C. Comparison of standard and super TFT display

<i>Standard</i>	<i>Super</i>
<ul style="list-style-type: none"> • good gray level resolution • F satisfactory viewing angle 	<ul style="list-style-type: none"> • very good viewing angle • satisfactory gray level resolution
Field of applications: <ul style="list-style-type: none"> • Image processing • medical field • Standard workstation • Banks (confidential area) 	Field of applications: <ul style="list-style-type: none"> • is several people are working at one screen. • Standard workstation • Presentation tasks • Banks (public area)

Important LCD parameters

A. Viewing angle

The viewing angle is the display's visible field. If one were to imagine a vertical line in the centre of the image and to pivot up and down and to the right and to the left from that point, then that is the viewing angle. †Working ergonomically requires a viewing angle of at least 60°/60° (right/left) horizontally and 45°/45° vertically (up/down). If only two values are specified for horizontal and vertical, the values for right and left, and for horizontal and vertical are added together. If this were the case then this would provide a viewing angle of 120° horizontally and 90° vertically.

B. Contrast

Contrast is the ratio between the light intensity of the brightest and the darkest point of an image. High contrast values improve readability and ergonomics.

A display should in all instances attain contrast values of 100:1. This is a point on which LCD monitors are clearly superior to monitors.

C. Response time

The response time is the time, which a TFT cell requires to switch on and switch off. †For standard applications a response time of a maximum of 70 ms (milliseconds) is sufficient. If a more rapid image build-up is required (e.g. the multimedia field), then values of a maximum of 30 ms are required.

D. Brightness

Brightness is the emitted luminous power over a specified area. Brightness is another point, on which LCD monitors are superior to CRT devices. Traditional monitors create approx. 80 to 100 cd/m² (candela per meter square). In the case of LC displays, values below 150 cm/m² are not acceptable.

Display errors

A. Pixel errors

Pixel errors are (unfortunately) unavoidable with today's production methods, if you want to manufacture displays at an economically sensible price.

A display with a resolution of 1024x768 dots therefore has 786432 pixels. Each pixel consists of the three sub-pixels for red, green and blue. That makes 2,359,296 individual control transistors. It can occur during production that one or several transistors is defective, which means that pixel errors occur, in which a sub-pixel does not light up at all or does so all of the time.

If you were to accept the same error rate as in the case of the strip mask, for which two horizontal lines are completely disrupted, then you would end up with a 2.6 percent error rate. The accepted error rates for LC displays are far lower, however. If, for example, you were to accept a tolerance of three permitted pixel errors per display, then you would end up with an error rate of 0.0038 per thousand.

B. Blurred image

You can also end up with blurred images with LC displays indeed whenever you depart from the native resolution. A display is built for a set resolution, smaller resolutions can only be displayed interpolated. If, for example, you want to display a resolution of 800x600 on a display with a native resolution of 1024x768, then each horizontal dot would have to display 1.28 dots of the resolution. This doesn't work of course and so intermediate values are calculated and this distorts the original image.

C. Multifrequency as opposed to Multiscan

LC displays require a digital control and because currently there is still no valid standard for a digital control, for the sake of compatibility there is a tendency to revert to the standard VGA connection. This is also ideal for monitors, as they require an analog signal.

The image digitally created in the computer is converted in the graphics card into an analog signal and thus directly controls a CRT monitor. If, however, you use the analog signal of the VGA connection for a digital LC display, then transducer electronics at the input of the display must cater for conversion back into digital signals. Two problems occur with this:

1. conversion losses:

The image is not so optimal as compared with direct, digital control. It can otherwise be the case that subsequent adjustments are necessary every couple of months on a regular basis. This is generally executed via the OSD or an automatic function)

2. Limitation to specific operating modes:

Nowadays A CRT monitor is usually a multiscan monitor, which means it can be operated within the limits of its horizontal and vertical frequency, even in non-standard modes. An LCD monitor, in contrast, is a multi-frequency monitor, which means it is only guaranteed to work together with specific modes (see list in the user's guide).

Comparison of CRT & LCD monitors

CRT monitor	Flat panel display
<p>Advantages:</p> <ul style="list-style-type: none"> • Multiscan monitor. • same quality in all resolutions. • proven connector standard • analog (infinite) colour depth • no pixel errors • also large proportions • inexpensive <p>Disadvantages:</p> <ul style="list-style-type: none"> • geometry errors possible • convergence errors possible • limited brightness and contrast values • only flicker-free from 72 Hz • sensitive to magnetic and electric fields • relatively high power consumption • high heat build-up • larger footprint • high weight 	<p>Advantages:</p> <ul style="list-style-type: none"> • no geometry errors • no convergence errors • excellent brightness and contrast values • flicker-free • insensitive to magnetic and electric fields • low power consumption • low heat build-up • small footprint • low weight <p>Disadvantages:</p> <ul style="list-style-type: none"> • Multi-frequency monitor. • best quality only in its native resolution. • Absence of standards • limited colour depth • pixel errors • no large proportions • expensive

Summary

Ultimately, it cannot be said that LCD monitors are superior to CRT monitors or vice-versa either. Rather when choosing which device to use you need to weigh up the advantages and disadvantages in order to decide which technology to use.

In the public and presentational arena, LC displays are definitely preferable over CRT monitors. In relation to the display workstation order, the small footprint is also an important argument and in this respect more favours flat panel displays. On the other hand, when it comes to particular colour depth, or you need a large viewable diagonal, the choice of a CRT monitor is still unrivalled.